

1200V/15A

SiC Schottky Barrier Diode

Characteristic

- Zero Reverse Recovery Current
- Positive temperature coefficient
- Temperature-independent performance
- High-speed switching
- Low switching loss
- Low heat dissipation requirements

Application

- Switching power supply
- Power factor correction
- Motor drive, traction
- Charging pile

Product Description

V_{RRM}	1200	V
$I_F(135^\circ\text{C})$	23	A
Q_C	82	nC

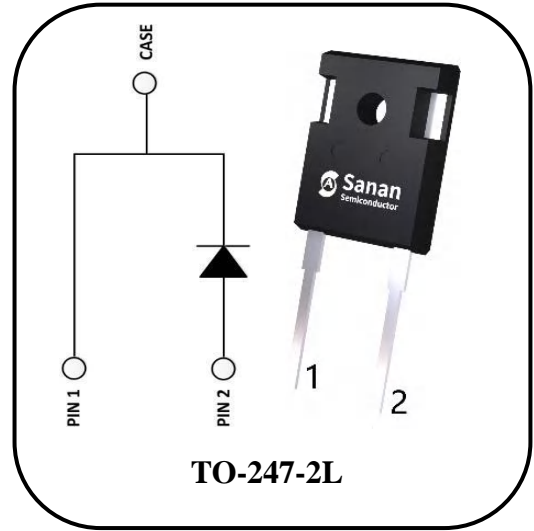

Device	Package	Marking
SDS120J015H3	TO-247-2L	DS120015H3

Absolute Maximum Ratings

Parameter	Symbol	Value	Unit	Test Conditions
Reverse voltage (Repetitive peak)	V_{RRM}	1200	V	$T_C=25^\circ\text{C}$
Reverse Voltage (Surge peak)	V_{RSM}	1200		$T_C=25^\circ\text{C}$
Reverse voltage (DC)	V_{DC}	1200		$T_C=25^\circ\text{C}$
Continuous forward current	I_F	51	A	$T_C=25^\circ\text{C}$
		23		$T_C=135^\circ\text{C}$
		15		$T_C=155^\circ\text{C}$
Surge non-repetitive forward current	I_{FSM}	140	A	$T_C=25^\circ\text{C}, t_p=10\text{ms}, \text{half Sine Pulse}$
Repetitive Peak Forward Surge Current	I_{FRM}	90	A	$T_C=25^\circ\text{C}, t_p=10\text{ms}, \text{half Sine Wave } D=0.1$
Total power dissipation	P_{TOT}	234	W	$T_C=25^\circ\text{C}$
i^2t value	$\int i^2 dt$	98	A^2s	$T_C=25^\circ\text{C}, t_p=10\text{ms}$
Operating temperature	T_j	-55~175	$^\circ\text{C}$	
storage temperature	T_{stg}	-55~175	$^\circ\text{C}$	
Mounting Torque	M	1	Nm	M3 Screw

Thermal Characteristics

Parameter	Symbol	Values			Unit	Test Condition
		Min.	Typ.	Max.		
Thermal resistance	$R_{th(j-c)}$	/	0.64	/	$^{\circ}\text{C}/\text{W}$	

Electrical Characteristics $T_j=25^{\circ}\text{C}$

Parameter	Symbol	Values			Unit	Test Condition
		Min.	Typ.	Max.		
DC blocking voltage	V_{DC}	1200	/	/	V	$I_R=100\ \mu\text{A}$
Forward voltage	V_F	/	1.35	1.50	V	$I_F=15\text{A}, T_j=25^{\circ}\text{C}$
		/	1.85	2.20		$I_F=15\text{A}, T_j=175^{\circ}\text{C}$
Reverse current	I_R	/	2	45	μA	$V_R=1200\text{V}, T_j=25^{\circ}\text{C}$
		/	15	240		$V_R=1200\text{V}, T_j=175^{\circ}\text{C}$
Total capacitance	C	/	1182	/	pF	$V_R=0\text{V}, f=1\text{MHz}$
		/	78	/		$V_R=400\text{V}, f=1\text{MHz}$
		/	57	/		$V_R=800\text{V}, f=1\text{MHz}$
Total capacitive charge	Q_C	/	82	/	nC	$V_R=800\text{V}$
Capacitance Stored Energy	E_C	/	24	/	μJ	$V_R=800\text{V}$

Typical Electrical Characteristics Curves

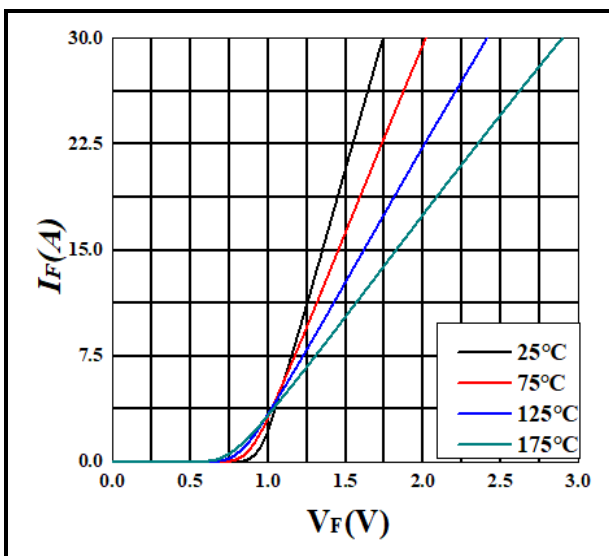

Figure 1. Forward Characteristics

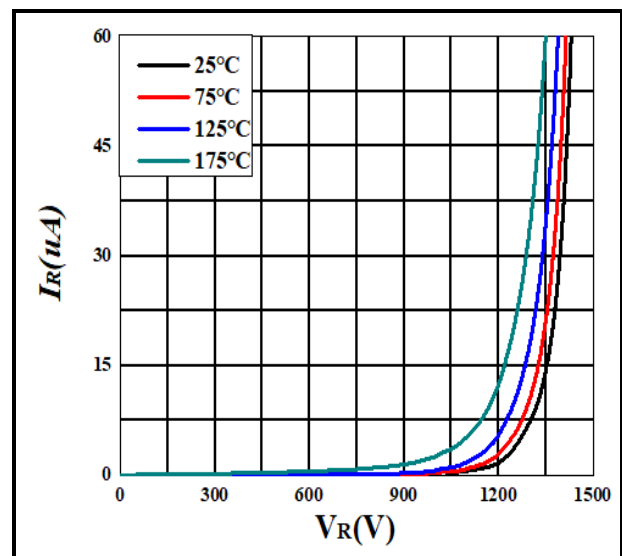

Figure 2. Reverse Characteristics

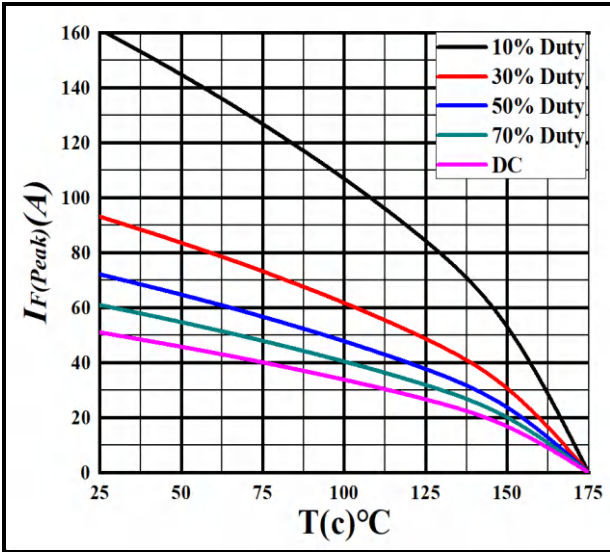

Figure 3. Current Derating

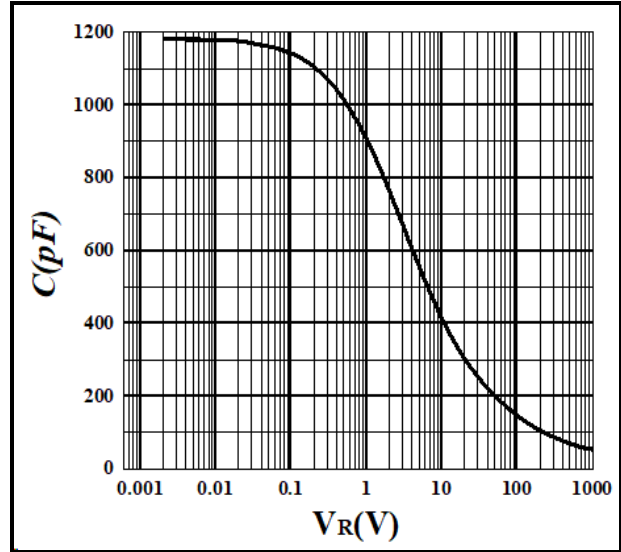

Figure 4. Capacitance vs. Reverse Voltage

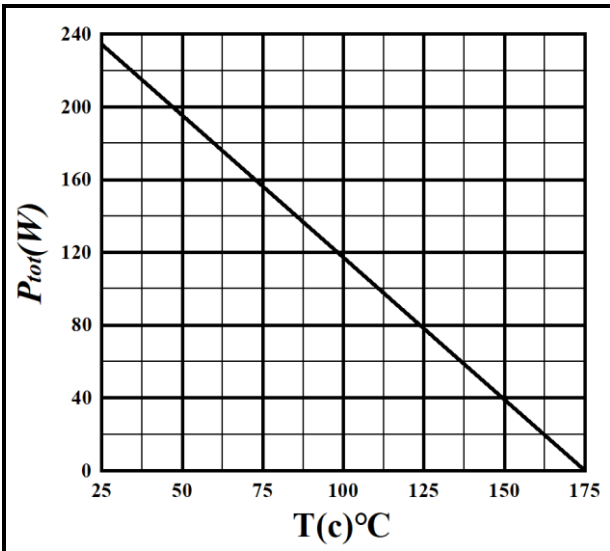

Figure 5. Power Derating

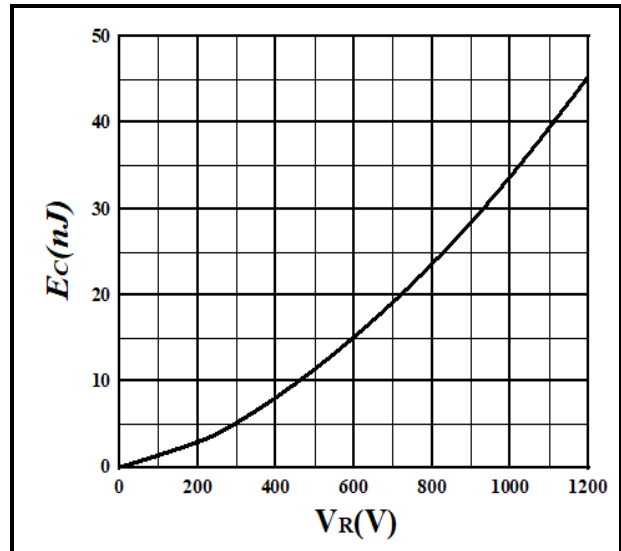

Figure 6. Capacitance Stored Energy

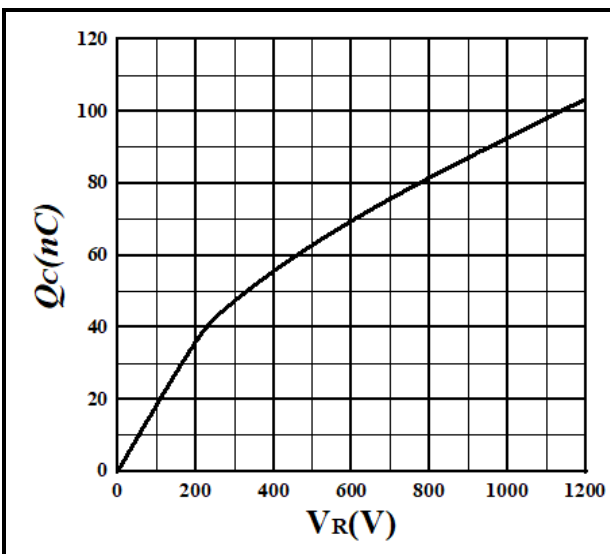
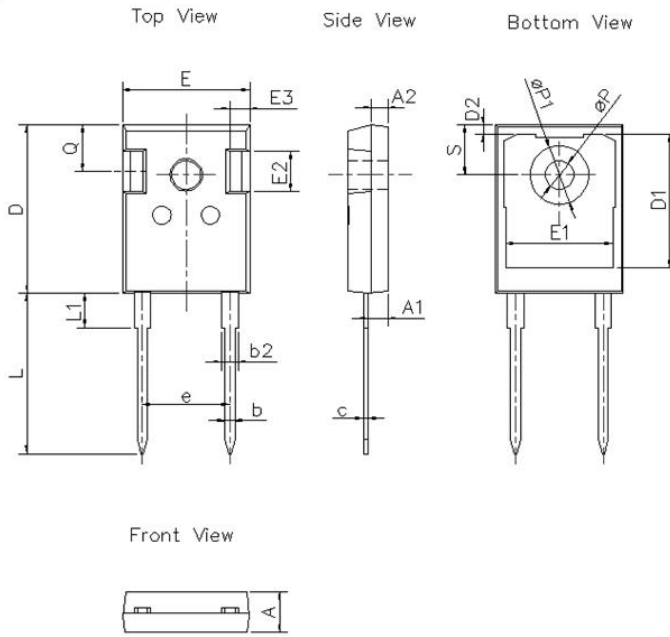

Figure 7. Total Capacitance Charge vs. Reverse Voltage

Package



Dimension unit: [mm]			
SYMBOL	MIN	NOM	MAX
A	4.80	5.00	5.20
A1	2.21	2.41	2.61
A2	1.85	2.00	2.15
b	1.11	1.21	1.36
b2	1.91	2.01	2.21
c	0.51	0.60	0.75
D	20.70	21.00	21.30
D1	16.25	16.55	16.85
D2	1.00	1.20	1.35
E	15.50	15.80	16.10
E1	13.00	13.30	13.60
E2	4.80	5.00	5.20
E3	2.30	2.50	2.70
e	10.88 BSC		
L	19.62	19.92	20.22
L1	-	-	4.30
ϕP	3.40	3.60	3.80
$\phi P1$	-	-	7.30
Q	5.40	5.80	6.20
S	6.20 BSC		

Ordering information

Part Number	SDS120J015H3-ISATH
Package	TO-247-2L
Unit Quantity	300 EA
Packing Type	Tube
RoHS	Yes